MEISTERSTÜCK (SO-610)

2.1 stereo music system



Operating manual

Table of contents

1	Introduction	67
1.1	Contact data	67
1.2	Intended use	68
2	Getting to know your MEISTERSTÜCK	68
2.1	Scope of delivery	68
2.2	Controls and ports	69
2.3	Technical data	70
2.4	Marks of approval and certificates	74
3	Getting started	75
3.1	Unpacking MEISTERSTÜCK.....	76
3.2	Inserting the battery in the remote control	76
3.3	Using the antennas	77
3.4	Performing initial setup	78
4	Basic operation	80
5	Using the menus	82
6	Display icons	83
7	FM Radio mode	84
7.1	Operation	84
7.2	Setup menu	85
8	DAB Radio mode	86
8.1	Operation	86
8.2	Setup menu	87
9	Internet Radio mode	89
9.1	Operation	89
9.2	Setup menu	90
9.3	Station List.....	90
9.4	Using the web portal	92
10	Streaming services	93
10.1	Operation	95
10.2	Setup menu	96
11	My Music mode	97
11.1	Operation	97
11.2	Setup menu	98

12	Bluetooth mode	100
12.1	Pairing	100
12.2	Operation	100
12.3	Setup menu	101
13	AUX In 1 mode	102
13.1	Operation	102
13.2	Setup menu	102
14	AUX In 2 mode	103
14.1	Operation	103
14.2	Setup menu	103
15	Optical mode	104
15.1	Operation	104
15.2	Setup menu	104
16	CD mode	105
16.1	Operation	105
16.2	Setup menu	106
17	Sleep timer	107
18	System Settings	108
18.1	Accessing the system settings	108
18.2	Streaming audio quality	108
18.3	Equalizer	108
18.4	Network	108
18.5	Time/date	109
18.6	Inactive standby	110
18.7	Language	110
18.8	Factory Reset	110
18.9	Software update	110
18.10	Setup Wizard	110
18.11	Info	110
18.12	Backlight	110
18.13	Multi-Room	111
19	Using UNDOK™ app to control MEISTERSTÜCK	112
20	Troubleshooting	114
21	Cleaning	116
22	Warranty	117

1 Introduction

Thank you for purchasing MEISTERSTÜCK. This operating manual and the safety manual provide all the information required for trouble-free and safe operation of MEISTERSTÜCK.

- Read the operating manual and the safety manual in their entirety before using MEISTERSTÜCK.
- Keep the operating manual and safety manual for future reference.
- If you pass MEISTERSTÜCK on to a third party, please provide them with the operating manual and safety manual as well.
- Failure to follow the operating manual and safety manual can result in serious injury or damage to MEISTERSTÜCK.
- We assume no liability for damage resulting from failure to observe the instructions in this operating manual and safety manual.

The images in this operating manual are intended to illustrate the actions necessary to operate MEISTERSTÜCK.

Enjoy your MEISTERSTÜCK!

1.1 Contact data

Address	sonoro audio GmbH, Nordkanalallee 94, 41464 Neuss, Germany
Phone	+49 2131 8834-141
Fax	+49 2131 7517-599
E-mail	support@sonoro.de
Internet	www.sonoro.de

1.2 Intended use

MEISTERSTÜCK is intended for personal use only. It is not intended for commercial use. MEISTERSTÜCK is solely intended for the following tasks:

- Playback of FM/DAB+/Internet radio and Spotify streaming service.
- Playback of 12cm audio CD and MP3/WMA CD disc.
- Audio playback from external devices connected via AUX In, USB port or Optical Input.
- Audio playback from Bluetooth-enabled devices (e.g. mobile phones).
- Music stream to Bluetooth headphone devices.
- Charging of external devices that are connected via the USB port.

Any other use is considered improper use and is prohibited. We assume no liability for damages resulting from improper use.

2 Getting to know your MEISTERSTÜCK

2.1 Scope of delivery

In addition to the MEISTERSTÜCK itself, the following accessories are also included in the scope of delivery:

- Remote control
- One button cell (CR2032, 3 V)
- Power cable
- FM/DAB cable antenna
- FM/DAB telescopic antenna
- External WiFi antenna
- Quick start guide
- Operating manual
- Safety manual
- Greeting card
- sonoro audio collection flyer
- Service address sheet
- Gloves

2.2 Controls and ports

Front view

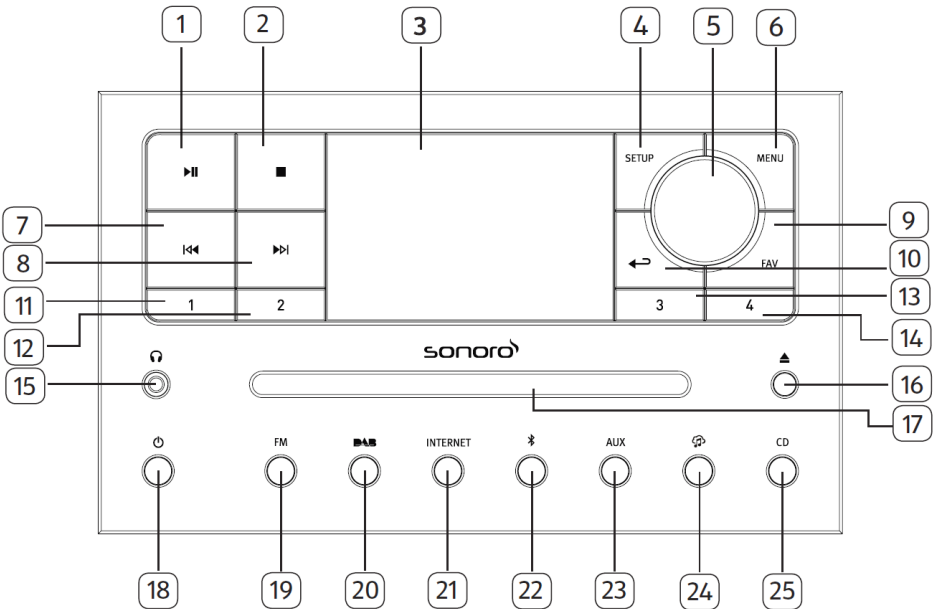

- | | |
|---|------------------------------------|
| 1. Play/pause button (▶) | 14. Preset 4 button (4) |
| 2. Stop button (■) | 15. Headphone jack (🎧) |
| 3. Display | 16. CD eject button (⬆) |
| 4. Setup button (SETUP) | 17. CD slot |
| 5. Volume knob, navigation knob
OK button (press the knob) | 18. Standby button (⏻) |
| 6. Menu button (MENU) | 19. FM Radio mode (FM) |
| 7. Left button, skip previous (⏮) | 20. DAB radio mode (DAB) |
| 8. Right button, skip next (⏭) | 21. Internet Radio mode (INTERNET) |
| 9. Favourite button (FAV) | 22. Bluetooth mode (📶) |
| 10. Back button (⬅) | 23. Auxiliary input 1/2 mode (AUX) |
| 11. Preset 1 button (1) | 24. Music streaming services (🎵) |
| 12. Preset 2 button (2) | 25. CD mode (CD) |
| 13. Preset 3 button (3) | |

Rear view

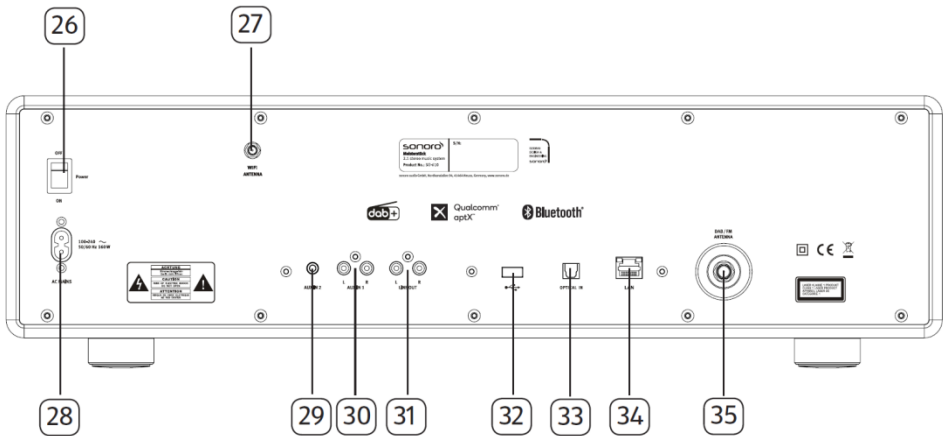

- 26. Main ON/OFF switch
- 27. External WiFi antenna jack
- 28. AC socket
- 29. Auxiliary input 2 (3.5mm)
- 30. Auxiliary input 1 (RCA)
- 31. Line-output (RCA)
- 32. USB port
- 33. Optical port
- 34. LAN RJ45 Jack
- 35. FM/DAB antenna jack

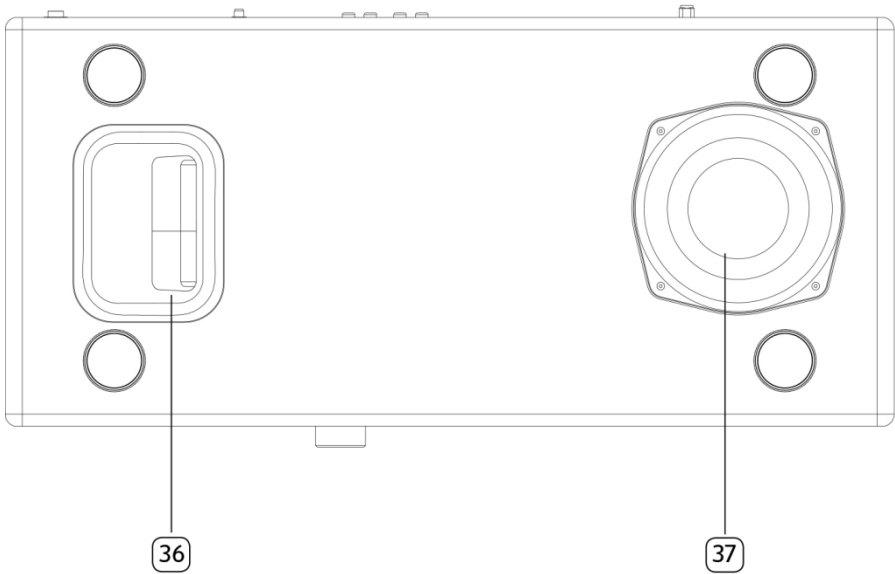
Bottom view

36. Bass reflex opening

37. Subwoofer driver

Remote control

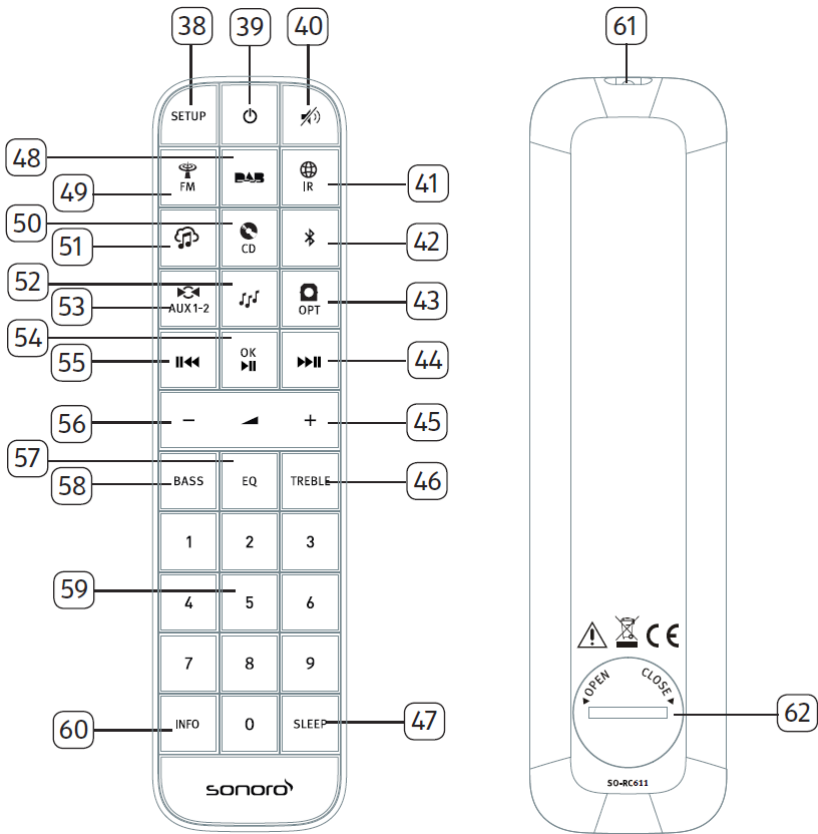

- | | |
|----------------------------------|---------------------------------------|
| 38. Setup button (SETUP) | 46. Treble button (TEREBLE) |
| 39. Standby button (⏻) | 47. Sleeper timer button (SLEEP) |
| 40. Mute button (🔇) | 48. DAB Radio mode (DAB) |
| 41. Internet Radio mode (🌐 IR) | 49. FM Radio mode (FM) |
| 42. Bluetooth mode (📶) | 50. CD mode (CD) |
| 43. Optical input mode (OPT) | 51. Music streaming services (🎵) |
| 44. Right button, skip next (▶▶) | 52. My Music mode (🎵) |
| 45. Volume up button (+)* | 53. Auxiliary input 1/2 mode (AUX1-2) |

-
54. Play/pause button (▶||), OK button
 55. Left button, skip previous (||◀◀)
 56. Volume down button (—)*
 57. Equalizer setting button (EQ)
 58. Bass setting button (BASS)
 59. Preset station buttons (1-9)
 60. Information button (INFO)
 61. Infra-red transmitter
 62. Battery compartment

*Navigation buttons (⊕, —)

2.3 Technical data

Specification	Value
Dimensions (WxDxH)	approx. 570 x 262 x 165 mm
Weight	approx. 9 kg
Operating temperature	0°C ~ +45°C
Display	2.8" TFT colour display
Frequency range, FM	87.50 MHz–108.00 MHz
DAB/DAB+	Band III, 174.928 MHz–239.200 MHz
Internet radio	More than 25,000 stations worldwide
Station presets	10 for each FM DAB/DAB+ Internet radio Spotify
CD support formats	CD-DA (12cm), CD-R*, CD-RW* Audio CD, MPEG 1 Layer 3 (MP3), Windows Media Audio (WMA, DRM not supported) Sampling rate 16KHz~48KHz, bit rate max. 320kbps (* Playback dependent on quality of recording and medium)
USB charging	Output: DC 5V \equiv 2.1A
USB playback	Compatibility system: FAT 16, FAT 32 (not compatible with NTFS or other systems)
AUX-IN	Port 1 : RCA jack Sensitivity: 1000 mV Port 2 : 3.5mm jack Sensitivity: 300 mV
Optical In, TOSLINK	Supports linear PCM Sample rate: 28KHz-216KHz Channel: Stereo 16 bit, 24bit
Streaming	Bluetooth Spotify DLNA UPnP
My music support media formats	AAC, AAC+, MP3, WAV, WMA, FLAC Max. 16 bits, 2 channels, sample rate 48KHz
Network supported	IEEE 802.11 a/b/g/n, 2.4 & 5GHz bands, Ethernet 2.412GHz-2.472GHz / 5.18GHz - 5.32GHz / 5.50GHz-5.70GHz
Max. transmitted power	< 20dBm
Encrypted key	WEP, WPA, WPA2 (PSK), WPS
Multi-room function	Maximum of 5 speakers in a group (4 client and 1 server)
Bluetooth	Version 3.0 Profile : AVRCP v1.4, A2DP 1.2, HSP v1.2 2.402GHz-2.480GHz
Max. transmitted power	< 10dBm
Battery	CR2032 (remote control)
Standby Power	< 1.0W
Network Standby	< 2.0W

2.4 Marks of approval and certificates



The Bluetooth® word mark and logos are registered trademarks owned by the Bluetooth SIG, Inc. and any use of such marks by sonoro audio GmbH is under license. Other trademarks and trade names are those of their respective owners.



UPnP™ is a trademark of the UPnP™ Forum.



The Spotify software is subject to third party licenses found here:
www.spotify.com/connect/third-party-licenses



Napster and Napster logo are registered trademarks of Rhapsody International Inc registered in the United States and other countries.



TIDAL and TIDAL logo are registered trademark of Aspiro AB in the European Union and other countries.



Deezer and Deezer logo are international trademarks of Deezer S.A., registered in France and other countries.



Qobuz and its logo are registered trademarks of Xandrie S.A.



Amazon, Amazon Music Unlimited and all related logos are trademarks of Amazon.com, Inc. or its affiliates.

3 Getting started

3.1 Unpacking MEISTERSTÜCK

1. Take MEISTERSTÜCK out of the packaging and check whether MEISTERSTÜCK or the individual parts exhibit damages. If this is the case, do not use MEISTERSTÜCK. Should you detect any damage, contact your dealer or sonoro audio GmbH customer support immediately.
2. Check to make sure that the delivery is complete (see chapter “Scope of delivery”).
3. Place MEISTERSTÜCK at a suitable location.
4. Remove the protective film from the display.
5. Remove the protective card from the subwoofer driver.

3.2 Inserting the battery in the remote control

1. Open the battery compartment cover on the back of the remote control by turning it anticlockwise using a small coin.
2. Insert the supplied batteries (CR2032, 3 V) with the label (+) side up.
3. Replace and close the battery compartment cover by turning the cover clockwise using a small coin.



i

Do not block the infra-red sensor on the MEISTERSTÜCK and the infra-red transmitter on the remote control during use.

3.3 Using the antennas

1. The scope of supply contains a cable antenna and a rod antenna. For optimum radio reception, one of the two antennae must be used.
2. Screw the desired antenna located on the back of MEISTERSTÜCK to the FM/DAB antenna connector.

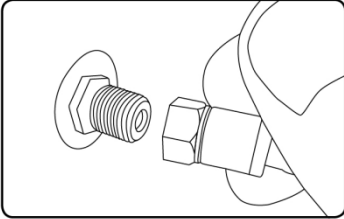

3. If you are using the cable antenna, unfold the cable antenna and align the antenna so that you have the best possible reception.

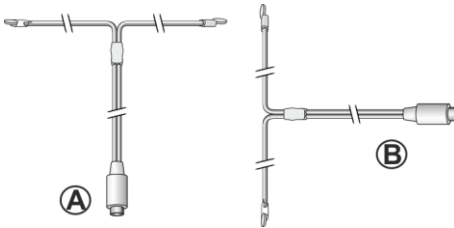

i

For good FM/DAB radio reception, the two ends of the cable antenna should form a 'T' (dipole) with the connection cable.

A: Recommended alignment for FM

B: Recommended alignment for DAB

For even better reception, attach the cable to a suitable house antenna.

4. If you are using the rod antenna, pull the arms of the rod antenna apart and align the antenna so that you have the best possible reception.
5. Screw the desired Wi-Fi antenna located on the back of MEISTERSTÜCK to the WiFi antenna connector. Lift Wi-Fi antenna upwards.

- If you want to connect MEISTERSTÜCK to your network using an Ethernet cable, connect an Ethernet cable from LAN port on the back of MEISTERSTÜCK to your router.

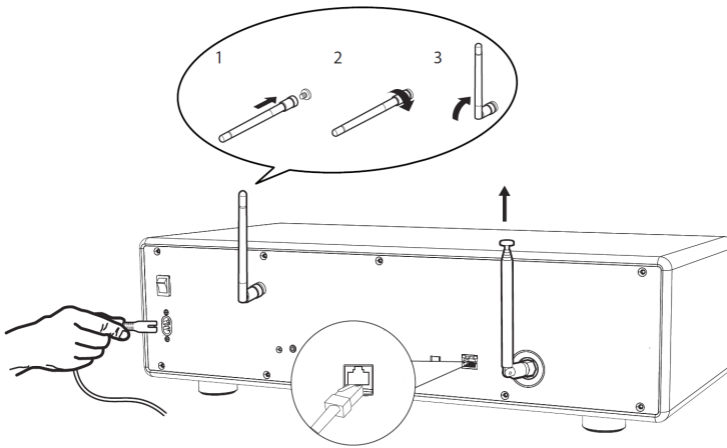

- Plug-in the AC power cord.

3.4 Performing initial setup

When MEISTERSTÜCK is powered on for the first time, the “Setup wizard” appears on the display. Follow the instructions below to configure some basic settings.

- When the “Setup Wizard” is displayed, press + or – on the remote control (or rotate the navigation knob) to select “YES” and then press OK to start the setup.



- You are then prompted to select:
 - Language (to be used in the display)
 - Time format (12 or 24-hour),
 - Source of auto update (Update from Radio, Internet or no update).

Depending on the selection you have made, follow the instructions on the display to further set up date and time, time zone, daylight saving

or wireless network. Rotate the navigation knob on MEISTERSTÜCK or press the navigation buttons on the remote control to make selections and then press OK to confirm (see chapter “Using the menus”).

When update from Internet is selected, Wi-Fi connection must be first established. When entering the key of your wireless network, rotate the navigation knob on MEISTERSTÜCK or press the navigation buttons on the remote control to select a character and then press OK to confirm. To delete the last entry, select [BKSP]. To cancel entering the key, select [CANCEL]. To confirm the entered key, select [OK].

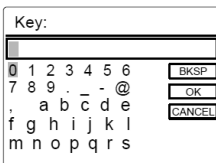

3. When “Setup wizard completed” appears, press OK to exit the setting.

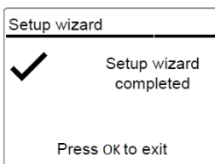





4. Alternative, use the Ethernet (LAN) connection to your router (with automatic configuration), select the [Wired] menu item in the available network.

i

To run the setup wizard again, go to [System Settings] and then select [Setup Wizard] (See chapter “System Settings”).

4 Basic operation

<p>To turn on,</p>	<p>Press ⏻. MEISTERSTÜCK starts operation from the last selected playback mode.</p>
<p>To turn off (standby mode),</p>	<p>Press ⏻. The time and date (if set) are displayed. MEISTERSTÜCK will automatically turn off without playback and operation after 15 minutes.</p>
<p>To select a playback mode,</p>	<p>Press MENU once, then ⏮ or ⏭ (or rotate the navigation knob) to select a playback mode and then press OK to confirm. Mode sequence: FM Radio > DAB Radio > Internet Radio > Bluetooth > Aux In 1 > Aux In 2 > Optical > CD > Spotify > TIDAL > Napster > Deezer > Qobuz > Amazon Music > My Music</p>
<p>To directly select a playback mode,</p>	<p>Press the direct operation mode key on the remote control or the front panel to directly switching from one operation mode to the other.</p>
<p>To playback a CD</p>	<p>Insert CD disc in CD slot and MEISTERSTÜCK starts playing the CD.</p>
<p>To control the volume,</p>	<p>Press + or – on the remote control or rotate the volume knob on MEISTERSTÜCK.</p>
<p>Pairing with a Bluetooth headphone, for the first time</p>	<p>In all operation modes except the Bluetooth mode, press and hold ⌘ key on MEISTERSTÜCK or remote control. Or, press SETUP once, then + or – (or rotate the navigation knob) to select [Bluetooth headphone], then select [Bluetooth pairing], then [Available devices], and then press OK to confirm. Wait for a while, your Bluetooth device name is shown in the display, and then select press OK to select it.</p>

	<p>The small Bluetooth headphone icon  is blinking and indicating that MEISTERSTÜCK is in pairing mode. The Bluetooth headphone icon  stops blinking when the pairing is completed. The paired Bluetooth headphone device name is temporarily shown in the display.</p> <p>Note: Make sure that your Bluetooth headphone is already in discovery mode and ready for pairing. For detail please refer to your Bluetooth device instruction manual.</p>
<p>Connecting with a paired Bluetooth headphone,</p>	<p>In all operation modes except the Bluetooth mode, press and hold  key on MEISTERSTÜCK or remote control. Or, press SETUP once, then + or – (or rotate the navigation knob) to select [Bluetooth headphone], then select [Bluetooth pairing], then [Paired devices], and then press OK to confirm. Your paired Bluetooth device names are shown in the display. Select your device and press OK to confirm.</p> <p>The small Bluetooth headphone icon  is blinking and indicates that MEISTERSTÜCK is in pairing mode. The Bluetooth headphone icon  stops blinking when the pairing is completed. The paired Bluetooth headphone device name is temporarily shown in the display.</p> <p>Note: Make sure that your Bluetooth headphone is already in pairing mode, for detail please refers to your Bluetooth device instruction manual.</p>
<p>To disconnect a paired Bluetooth headphone</p>	<p>Press SETUP once, then + or – (or rotate the navigation knob) to select [Bluetooth headphone], then select [Bluetooth disconnect] and then press OK to confirm.</p>

5 Using the menus



















There are three types of menus in MEISTERSTÜCK.

- Setup menu (For specific settings in a playback mode, e.g. [FM Auto Search] in FM mode)
- System Settings (For general settings, e.g. time/date, language etc.)
- Main menu (For accessing the playback modes and sleep time)

To access the menus,	Press SETUP. Contents of the menus may differ in different playback modes.
To select an option in the menus,	Rotate the navigation knob on MEISTERSTÜCK or press + or – on the remote control.
To confirm a selection in the menus,	Press OK. (On MEISTERSTÜCK, press the navigation knob)
To go back one level in the menu,	Press ←↵.



6 Display icons

Refer to the table below for the meanings of the display icons when they show on the display.

	Wi-Fi connection is established (with signal strength).
	Wi-Fi connection is disconnected.
	LAN connection is established.
	LAN connection is unplugged.
	A Bluetooth device is connected.
	A Bluetooth headphone is connected.
	The radio station is in the preset list.
	FM RDS information is received.
	Radio signal is being received (with signal strength).
	Repeat all playback mode is active.
	Repeat one playback mode is active
	Repeat folder playback mode is active
	Shuffle playback mode is active.
	Repeat all and shuffle playback mode is active.
	Sleep timer is active.
	Stereo sound broadcast is available.
	Sound output is muted.
	A USB device is connected.
	Playback is paused.

7 FM Radio mode

7.1 Operation

<p>To access the FM Radio mode,</p>	<p>Press  key on MEISTERSTÜCK or remote control.</p> <p>Or, press MENU once, then ⏮ or ⏭ (or rotate the navigation knob) to select the FM Radio mode and then press OK to confirm.</p>
<p>To manually tune the frequency,</p>	<p>Press ⏮ or ⏭.</p> <p>Or, press and hold the navigation knob to active the manual tune.</p>
<p>To automatically tune to the next available station,</p>	<p>Press and hold ⏮ or ⏭.</p> <p>Or, press the navigation knob to start the automatic tuning.</p>
<p>To store a radio station in the preset list,</p>	<p>A maximum of 10 radio stations can be stored.</p> <ol style="list-style-type: none"> 1. Press and hold the FAV key on MEISTERSTÜCK until the preset list is shown. 2. Press + or – (or rotate the navigation knob) to select a preset station number and then press OK to confirm.
<p>To directly store a radio station in the preset list (1–9),</p>	<p>Tune to a station and then press and hold a preset station button (1–9) to directly store it in the preset list.</p>
<p>To recall a radio station in the preset list,</p>	<ol style="list-style-type: none"> 1. Press FAV. 2. Press + or – (or rotate the navigation knob) to select a radio station in the preset list and then press OK to confirm. <p>Or, press preset station button (0–9) to access a stored preset station (1–10).</p>
<p>To browse the radio station information (if available),</p>	<p>Press INFO repeatedly.</p>
<p>To mute or restore the sound output,</p>	<p>Press  or ⏸ button.</p>

7.2 Setup menu

Press SETUP in the FM mode to access the setup menu (see chapter “Using the menus”). The following options are available and the current settings (if applicable) are marked with an asterisk (*).

- [FM Auto Search]
To auto store all available radio stations in the preset list.*
* All existing preset stations will be erased.
- [FM Scan Setting]
To decide if only stations with strong signals are scanned when performing automatic tuning.
- [FM Reception Setting]
To listen radio in stereo or mono sound output.
- [Bluetooth headphone]
To connect or disconnect with a Bluetooth headphone, see chapter “Basic operation”.
- [System Settings]
See chapter “System Settings”.
- [Main menu]
To access other playback modes or sleep timer.

8 DAB Radio mode

8.1 Operation

<p>To access the DAB Radio mode,</p>	<p>Press the DAB key on MEISTERSTÜCK or remote control.</p> <p>Or press MENU once, then ⏪ or ⏩ (or rotate the navigation knob) select the DAB Radio mode and then press OK to confirm.</p>
<p>To search for DAB radio stations,</p>	<p>The first time you select the DAB mode, or if the station list is empty, MEISTERSTÜCK will automatically perform a full scan and store all available stations in the station list.</p>
<p>To tune to a station,</p>	<p>Press ⏪ or ⏩.</p>
<p>To store a radio station in the preset list,</p>	<p>A maximum of 10 radio stations can be stored.</p> <ol style="list-style-type: none"> 1. Press and hold the FAV key on MEISTERSTÜCK until the preset list is shown. 2. Press + or – (or rotate the navigation knob) to select a preset station number and then press OK to confirm.
<p>To directly store a radio station in the preset list (1–9),</p>	<p>Tune to a station and then press and hold a preset station button (1–9) to directly store it in the preset list.</p>
<p>To recall a radio station in the preset list,</p>	<ol style="list-style-type: none"> 1. Press FAV. 2. Press + or – (or rotate the navigation knob) to select a radio station in the preset list and then press OK to confirm. <p>Or, press a preset station button (0–9) to access a stored preset station (1–10).</p>
<p>To browse the radio station information* (if available),</p>	<p>Press INFO repeatedly.</p>
<p>To mute or restore the sound output,</p>	<p>Press 🔇 or ⏩ button.</p>

*DAB information (if available) includes: Station name, Dynamic Label Segment (DLS), Signal strength, Program type (PTY), Ensemble Name, Frequency, Signal error rate, Bit rate and audio status, Codec, and Time and date.

8.2 Setup menu

Press SETUP in the DAB mode to access the setup menu (see chapter “Using the menus”). The following options are available and the current settings (if applicable) are marked with an asterisk (*).



- [Station List]
To display all available stations.
- [Scan]
To scan and store all available stations.
- [Manual Tune]
To manually tune the frequency. The list of available digital radio ensembles is shown.
- [Prune invalid Stations]
To remove all invalid stations from the station list.
- [DRC]
Some DAB broadcasts offer dynamic range compression (DRC). Compressing the dynamic range of a radio signal can increase the volume of quiet sounds and reduce the volume of loud sounds. You can select high, low or off level. High level is recommended for noisy environment.
- [Station Order]
To define how the stations are listed when browsing the station list. Options are:
 - [Alphanumeric]: Arrange the stations in alphabetical order,
 - [Ensemble]: List groups of stations that are broadcast together on the same ensemble, and
 - [Valid]: List valid stations first, then off-air stations.

- [Bluetooth headphone]
To connect or disconnect with a Bluetooth headphone, see chapter “Basic operation”.
- [System Settings]
See chapter “System Settings”.
- [Main menu]
To access other playback modes or sleep timer.

9 Internet Radio mode

9.1 Operation

Wi-Fi or Ethernet Internet connection must be established first to use the Internet radio (see chapters “Performing initial setup” and “Network”).

<p>To access the Internet Radio mode,</p>	<p>Press the INTERNET key on MEISTERSTÜCK or remote control  key.</p> <p>Or, press MENU once, then ⏮ or ⏭ (or rotate the navigation knob) to select the Internet Radio mode and then press OK to confirm.</p> <p>MEISTERSTÜCK starts connecting to the previously connected network and then the last listened station.</p>
<p>To tune to a radio station or podcast,</p>	<p>See chapter “Station List”.</p>
<p>To store a radio station in the preset list,</p>	<p>A maximum of 10 radio stations can be stored.</p> <ol style="list-style-type: none"> 1. Press and hold the FAV key on MEISTERSTÜCK until the preset list is shown. 2. Press + or – (or rotate the navigation knob) to select a preset station number and then press OK to confirm.
<p>To directly store a radio station in the preset list (1–9),</p>	<p>Tune to a station and then press and hold a preset station button (1–9) to directly store it in the preset list.</p>
<p>To recall a radio station in the preset list,</p>	<ol style="list-style-type: none"> 1. Press FAV key. 2. Press + or – (or rotate the navigation knob) to select a radio station in the preset list and then press OK to confirm. <p>Or, press preset station buttons (0–9) to access a stored preset station (1–10).</p>
<p>To browse the station information* (if available),</p>	<p>Press INFO repeatedly.</p>
<p>To mute or restore the sound output,</p>	<p>Press  button.</p>

*Station information (if available) includes: Artist and track name, Station description, Station genre and location, Signal reliability, Codec and sampling rate, Playback buffer, and Date.

9.2 Setup menu

Press SETUP in the Internet Radio mode to access the setup menu (see chapter “Using the menus”). The following options are available and the current settings (if applicable) are marked with an asterisk (*).

- [Last listened]
To tune to your last listened radio stations.
- [Station List]
To tune to any available Internet radio stations (See chapter “Station list”).
- [Bluetooth headphone]
To connect or disconnect with a Bluetooth headphone, see chapter “Basic operation”.
- [System Settings]
See chapter “System Settings”.
- [Main menu]
To access other playback modes or sleep timer.

9.3 Station List

The following menus and sub-menus are available in the [Station List]:

- [My Favourites]
To browse and tune to the Internet radio stations that you have added to “My favourites” on the web portal (See chapter “Using the web portal”).
- [Local (name of your location)]
To browse and tune to any radio stations available in your area. The stations are grouped into several categories.

- [Stations]
 - [Location]: To browse and tune to radio stations by location.
 - [Genre]: To browse and tune to radio stations by genre.
 - [Search stations]: To search for any available radio stations by entering keywords.
 - [Popular stations]: To browse and tune to the most popular Internet radio stations.
 - [New stations]: To browse and tune to the latest Internet radio stations.
- [Podcasts]
 - [Location]: To browse and tune to podcasts by location.
 - [Genre]: To browse and tune to podcasts by genre.
 - [Search podcasts]: To search for any available podcasts by entering keywords.
- [My Added Stations]

To browse and tune to the radio stations that you have added to “My added stations” on the web portal (See chapter “Using the web portal”).
- [Help]
 - [Get access code]: To get the access code of MEISTERSTÜCK.
 - [FAQ]: To get help when the Internet radio does not work properly.

9.4 Using the web portal

The Frontier Silicon Internet Radio portal website allows you to organise your “My favourites” and add new Internet radio stations on a computer. To do so, you need to first register at the web portal.

1. In the Internet Radio mode, press SETUP and then go to [Station List] > [Help] > [Get access code]. Write down the access code.
2. Go to www.wifiradio-frontier.com on the web browser of your computer.
3. Register a new account with the access code.
4. Following the instructions in the web portal, use the “My favourites” and “My added stations” features to add radio stations.

The added stations in “My favourites” can be accessed through [My favourites] in the Internet Radio mode of MEISTERSTÜCK.

The added stations in “My added stations” can be accessed through [My added stations] in the Internet Radio mode of MEISTERSTÜCK.

10 Streaming services

Your MEISTERSTÜCK can play content from the following streaming services:



You will also find the symbols of these services in the display of your MEISTERSTÜCK.

i

Please note: The use of streaming services requires contracts with the streaming providers; these may cause costs. In particular, free offers often contain advertising. Changes are in the responsibility of the streaming services. Please inform yourself on the homepages of the providers.

We recommend that you first install the UNDOK™ app on the device that you want to use to control your MEISTERSTÜCK (this can be a smartphone or tablet, for example).

i

This device (eg. smartphone) must be in the same network as your MEISTERSTÜCK!







For hints how to deal with the UNDOK™ app please refer to chapter 19.

i

Occasionally, the services can also be operated directly with the providers app or the MEISTERSTÜCK itself. Please check with the provider.

10.1 Operation

The procedures described below applies analogously to all available streaming services.

<p>Selection of a streaming service</p>	<p>Press the  key on MEISTERSTÜCK or remote control and go to the selection of desired streaming service. The symbols of the services listed above will appear accordingly in the display of your MEISTERSTÜCK.</p> <p>Or, press MENU once, then  or  (or rotate the navigation knob) to select the desired streaming service and then press OK to confirm.</p>
<p>Log in a streaming account (TIDAL, Napster, Qobuz, Amazon Music),</p>	<p>To use a streaming service on your masterpiece, sign in to MEISTERSTÜCK or the UNDOK™ app installed on your mobile device with your account. Follow the instructions on the screen.</p>
<p>How to use Spotify Connect,</p>	<ol style="list-style-type: none"> 1. Connect your MEISTERSTÜCK to your wifi network. 2. Open up the Spotify app on your phone, laptop or tablet using the same wifi network. 3. Play a song and select Devices Available. 4. Select your MEISTERSTÜCK and start listening.
<p>To pause or resume playback,</p>	<p>Press .</p>
<p>To skip to the previous or next playback item,</p>	<p>Press  or .</p>

<p>To store a playback item in the preset list,</p>	<p>A maximum of 8 playback items can be stored.</p> <ol style="list-style-type: none"> 1. Press SETUP until the save to preset is shown then press OK to confirm. 2. Press + or – (or rotate the navigation knob) to select a preset item number and then press OK to confirm.
<p>To directly store a playback item in the preset list (1–8),</p>	<p>Select a playback item and then press and hold a preset station button (1–8) to directly store it in the preset list.</p>
<p>To recall a playback item in the preset list,</p>	<ol style="list-style-type: none"> 1. Press FAV key. 2. Press + or – (or rotate the navigation knob) to select a playback item in the preset list and then press OK to confirm. <p>Or, press preset station buttons (1–8) to directly access a preset playback item (1–8).</p>
<p>To browse the information (if available) of the playback item,</p>	<p>Press INFO repeatedly.</p>

10.2 Setup menu

Press SETUP in the Music streaming services to access the setup menu (see chapter

“Using the menus”). The following options are available and the current settings (if applicable) are marked with an asterisk (*).

- [Bluetooth headphone]

To connect or disconnect with a Bluetooth headphone, see chapter “Basic operation”.
- [System Settings]

See chapter “System Settings”.
- [Main menu]

To access other playback modes or sleep timer.

11 My Music mode

NOTICE!

Risk of damage!









Improper handling of the MEISTERSTÜCK may cause damage.





- Do not connect the MEISTERSTÜCK directly to the USB port of a computer or other external storage media such as external hard disk.

i

My Music mode can play back audio files stored on a connected USB memory stick or from a media server (UPnP) sharing the same Wi-Fi network with the MEISTERSTÜCK.

11.1 Operation

To access the My Music mode,	Press the  key on the remote control. Or, press MENU once, then  or  (or rotate the navigation knob) to select the My Music mode and then press OK to confirm.
To play back audio files stored on a USB memory stick,	Connect the USB memory stick to the USB port of MEISTERSTÜCK. Then press SETUP and select [USB Playback] from the setup menu (see chapter “Setup menu” on next page).
To pause or resume playback,	Press  .
To skip to the previous or next audio file,	Press  or  .
To quickly search backward or forward within an audio file,	During playback, press and hold  or  .

To add an audio file to “My Playlist”,	Press and hold ► or the navigation knob when the file is highlighted in the selection menu.
To select a playback mode,	Press FAV repeatedly. <ul style="list-style-type: none"> ▪  = Repeat all ▪  = Repeat one ▪  = Shuffle ▪  = Repeat all and shuffle
To browse the information (if available) of the audio file,	Press INFO repeatedly.

11.2 Setup menu

Press SETUP in the My Music mode to access the setup menu (see chapter “Using the menus”). The following options are available and the current settings (if applicable) are marked with an asterisk (*).

- [Shared Media]
 - To search for audio files on the Wi-Fi or Ethernet network.
 - Once a media server has been found, a selection menu will show for selection of audio files for playback from MEISTERSTÜCK.
- [USB Playback]
 - To search for audio files on the connected USB memory stick.
 - Once a USB memory stick has been found, a selection menu will show for selection of audio files for playback from MEISTERSTÜCK.
- [MyPlaylist]
 - To browse and play back audio files stored in “My playlist”.
- [Repeat]
 - To turn on or off the repeat playback mode of the current folder/playlist.
- [Shuffle]
 - To turn on or off the shuffle playback mode of the current folder/playlist.

- [Clear My Playlist]
To clear entries from “My Playlist”.
- [Prune Servers]
If this setting is set to “YES”, inactive media servers will be displayed. You can then select a media server and “wake it up” (WOL “wake on LAN” function) in order to play back audio files from MEISTERSTÜCK.
- [Bluetooth headphone]
To connect or disconnect with a Bluetooth headphone, see chapter “Basic operation”.
- [System Settings]
See chapter “System Settings”.
- [Main menu]
To access other playback modes or sleep timer.

12 Bluetooth mode

MEISTERSTÜCK can connect to Bluetooth-enabled players (e.g. mobile phone) within a range of approximately 10 meters (30 feet).









12.1 Pairing

1. Press  key on MEISTERSTÜCK or remote control. Or, press SETUP once, then + or – (or rotate the navigation knob) to select the Bluetooth mode and then press OK to confirm.

The small Bluetooth icon  is blinking, indicating that MEISTERSTÜCK is ready for pairing.

2. On your Bluetooth-enabled player, turn on the Bluetooth function and search for available Bluetooth devices.
3. Select “MEISTERSTUECK” in the list of available Bluetooth devices to start pairing.
4. The Bluetooth icon  stops blinking when pairing is complete.

12.2 Operation

To access the Bluetooth audio mode,	Press  key on MEISTERSTÜCK or remote control. Or, press MENU once, then  or  (or rotate the navigation knob) to select the Bluetooth mode and then press OK to confirm.
To start playback,	Select an audio file from your Bluetooth-enabled player and start playback.
To pause or resume playback,	Press  .
To skip to the previous or next audio file,	Press  or  .
To quickly search backward or forward within an audio file,	During playback, press and hold  or  .

<p>To disconnect the Bluetooth connection,</p>	<ul style="list-style-type: none"> ▪ Switch to another playback mode, or ▪ Select [BT disconnect] from the setup menu (see below), or ▪ Press and hold ⓧ.
<p>To browse the information (if available) of the audio file,</p>	<p>Press INFO repeatedly.</p>

12.3 Setup menu



Press SETUP in the Bluetooth audio mode to access the setup menu (see chapter “Using the menus”). The following options are available and the current settings (if applicable) are marked with an asterisk (*).

- [Bluetooth disconnect]
 - To disconnect the Bluetooth connection.
- [View Details]
 - [Bluetooth Info]: To get the existing Bluetooth connection status.
 - [Connected Device]: To get the existing connected Bluetooth device name.
- [System Setting]
 - See chapter “System Settings”.
- [Main menu]
 - To access other playback modes or sleep timer.

13 AUX In 1 mode

13.1 Operation

Your external player (e.g. Blu-ray player) must be connected to the auxiliary input jack 1 of MEISTERSTÜCK with an audio cable (with RCA connector, not supplied).

To access the AUX In 1 mode,	Press  key on MEISTERSTÜCK or remote control to toggle AUX In. 1 mode. Or, press MENU once, then ⏮ or ⏭ (or rotate the navigation knob) to select the AUX In 1 mode and then press OK to confirm.
To start and control playback,	Perform all playback operations on the external player.
To mute or restore the sound output,	Press  or ⏸ button.

13.2 Setup menu





Press SETUP in the AUX In 1 mode to access the setup menu (see chapter “Using the menus”). The following options are available and the current settings (if applicable) are marked with an asterisk (*).

- [Bluetooth headphone]
To connect or disconnect with a Bluetooth headphone, see chapter “Basic operation”.
- [System Settings]
See chapter “System Settings”.
- [Main menu]
To access other playback modes or sleep timer.

14 AUX In 2 mode

14.1 Operation

Your external player (e.g. mp3 player) must be connected to the auxiliary input jack 2 of MEISTERSTÜCK with an audio cable (with 3.5 mm connector, not supplied).

To access the auxiliary input 2 mode,	Press  key on MEISTERSTÜCK or remote control to toggle AUX In. 2. Or, press MENU once, then  or  (or rotate the navigation knob) to select the AUX In 2 mode and then press OK to confirm.
To start and control playback,	Perform all playback operations on the external player.
To mute or restore the sound output,	Press  or  button.

14.2 Setup menu



Press SETUP in the AUX In 2 mode to access the setup menu (see chapter “Using the menus”). The following options are available and the current settings (if applicable) are marked with an asterisk (*).

- [Bluetooth headphone]
To connect or disconnect with a Bluetooth headphone, see chapter “Basic operation”.
- [System Settings]
See chapter “System Settings”.
- [Main menu]
To access other playback modes or sleep timer.

15 Optical mode

15.1 Operation

Your external player (e.g. audio amplifier) must be connected to the optical input jack of MEISTERSTÜCK with an audio cable (with optical connector, not supplied).

To access the Optical mode,	Press  key on the remote control. Or, press MENU once, then ⏮ or ⏭ (or rotate the navigation knob) to select the Optical mode and then press OK to confirm.
To start and control playback,	Perform all playback operations on the external player.
To mute or restore the sound output,	Press  or ⏸ button.

15.2 Setup menu

Press SETUP in the optical input mode to access the setup menu (see chapter “Using the menus”). The following options are available and the current settings (if applicable) are marked with an asterisk (*).

- [Bluetooth headphone]
To connect or disconnect with a Bluetooth headphone, see chapter “Basic operation”.
- [System Settings]
See chapter “System Settings”.
- [Main menu]
To access other playback modes or sleep timer.

i

The optical input is only supporting for the linear PCM, 2 channels 16 bit or 24bit music source.

16 CD mode

NOTICE!













Risk of damage!

Improper handling of the MEISTERSTÜCK may cause damage.

- Do not insert any mini-CD or not supporting format disc to the MEISTERSTÜCK.

16.1 Operation

MEISTERSTÜCK can playback audio files stored on an audio CD, CD-R and CD-RW. The playback is also depending on the disc quality.

To access the CD mode,	Press  key on MEISTERSTÜCK or remote control. Or press MENU once, then  or  (or rotate the navigation knob) to select the CD mode and then press OK to confirm.
To pause or resume playback,	Press  .
To stop playback,	Press  .
To skip to the previous or next audio file,	Press  or  .
To quickly search backward or forward within an audio file,	During playback, press and hold  or  .
To select a playback mode,	Press FAV repeatedly. <ul style="list-style-type: none"> ▪  = Repeat all ▪  = Repeat one ▪  = Shuffle

To browse the information (if available) of the audio file,

Press INFO repeatedly.

16.2 Setup menu

Press SETUP in the CD mode to access the setup menu (see chapter “Using the menus”). The following options are available and the current settings (if applicable) are marked with an asterisk (*).

- [Resume setting]

The CD will resume playback from the last played position, even if you have switched modes or switch the device to Standby mode. This function is terminated when you eject the CD. This function is intended for audio books, for example.

- [Bluetooth headphone]

To connect or disconnect with a Bluetooth headphone, see chapter “Basic operation”.

- [System Settings]

See chapter “System Settings”.

- [Main menu]

To access other playback modes or sleep timer.

17 Sleep timer

The sleep timer sets the duration of time before MEISTERSTÜCK turns off automatically.

1. Press SETUP in any playback mode and then select [Main menu] and then [Sleep].
Or, direct press SLEEP button to turn the sleep timer on or off.
2. Press + or – (or rotate the navigation knob) to select a sleep timer (15, 30, 45, 60 or 90 min).
3. Press OK to confirm the selection.

When the sleep timer is active, the sleep timer icon () and the remaining time will be shown. To cancel the sleep timer, select [Sleep OFF].

18 System Settings

18.1 Accessing the system settings

- Press SETUP in any playback mode and then select [System Settings]
- Refer to the chapters below for details of each setting option. The current settings (if applicable) are marked with an asterisk (*).
- See chapter “Using the menus” for browsing and making selections in the system settings.

18.2 Streaming audio quality

The three quality options presented in the System setting apply to music streaming services only.

- [Low quality] : Corresponds to the services’ lowest quality.
- [Normal quality] : Corresponds to the services’ mid-level quality.
- [High quality] : Corresponds to the services’ highest quality.

18.3 Equalizer

Select one of the sound equalizer options to adjust the sound according to your taste.

- [3D Sound]
3D Sound on, it extends the stereo area, thus improving the depth of the music playback.
- [Loudness]
Loudness on, it adapts the treble and bass levels to suit the current volume, so that delicate sounds can still be heard clearly when you listen to your music quietly.
- [Bass]
Adjust the bass level to tailor the sound of the audio playback.
- [Treble]
Adjust the treble level to tailor the sound of the audio playback.
- Select one of the pre-defined sound equalizer options including: [Flat], [Pop], [Rock], [Jazz] and [Classic].

18.4 Network

- [Network wizard]
To establish network connection.

- [WPS WLAN Setup]
Select this option if your wireless router supports both WPS and PBC setup methods.
- [View Settings]
To view the current network information.
- [WLAN Region]
To select a WLAN region.
- [Manual Settings]
Under the [Wireless] option, select [DHCP enable] to allocate IP address automatically or [DHCP disable] to do it manually.
- [NetRemote PIN setup]
To set up a NetRemote PIN.
- [Network Profile]
To display a list of networks saved by MEISTERSTÜCK.
- [Clear Network Setting]
To clear all network settings.
- [Keep Network Connected]
To keep the WiFi network connected or not. If [YES] is selected, this allows you to wake MEISTERSTÜCK from standby using a remote app. If [NO] is selected, this will switch OFF the WiFi network connection in standby mode.

18.5 Time/date

- [Set Time/Date]
To set time and date.
- [Auto Update]
To select a source (Radio, Internet network or no update) for automatic time update.

If you are updating time from a source (Radio – FM/DAB), the daylight saving setting has no effect.

If you are updating time from the Internet network, set your time zone.
- [Set Format]

To set 12 or 24-hour time format.

- [Set Timezone]

To set a time zone.

- [Daylight Savings]

To enable or disable daylight saving time.

18.6 Inactive standby

- This option sets the duration of time before MEISTERSTÜCK turns off automatically. Options include: Off, 2, 4, 5 and 6 hours.

18.7 Language

- This option sets the menu language. Options include: English, German, Danish, Spanish, French, Italian, Dutch, Norwegian, Polish, Portuguese, Finnish, Swedish and Turkish.

18.8 Factory Reset

- This option clears all user-defined settings and replaces them with the original default settings.

18.9 Software update

- [Auto check]

To set to periodically check for update.

- [Check now]

To check for update immediately.

If a new software is available, MEISTERSTÜCK will ask if you want to proceed with an update.

Before software upgrade, make sure that MEISTERSTÜCK is connected to a stable power connection. Disconnecting power during a software update may damage MEISTERSTÜCK.

18.10 Setup Wizard

- To perform initial setup (see chapter “Performing initial setup”).

18.11 Info

- This shows the current software version, spotify version, radio ID and friendlyname.

18.12 Backlight

- [Dimmer level]

To select the brightness level of the display. Options include: [High], [Medium], [Low] or [Auto].

If [Auto] is selected, the brightness level is automatically adjusted according to the ambient light sensor at the front of MEISTERSTÜCK.

18.13 Multi-Room

Your MEISTERSTÜCK can be used with other compatible products as part of a multi-room system. Products under the same Wi-Fi network and synchronised in the same multi-room group can play the same content around your home. You may also create multiple groups for different areas of the home or for different users.

You can configure the multi-room groups in the system settings with the following options:

- [View Details]

To view your current multi-room status:

- [Ungrouped]: MEISTERSTÜCK is not part of a group.
- [Server]: MEISTERSTÜCK sends audio content to other group members.
- [Client]: MEISTERSTÜCK receives audio content from another product in the group.

- [Create New Group]

To create a new multi-room group.

- [Add to Group]

To add other compatible products to a current multi-room group.

- [List Current Clients]

To view the list of compatible products receiving audio contents from MEISTERSTÜCK.

- [Leave Group]

To remove compatible products from a multi-room group.

- [Dissolve Group]

To dissolve a multi-room group. Each product in the group will then be operated individually.

19 Using UNDOK™ app to control MEISTERSTÜCK

MEISTERSTÜCK is compatible with the Frontier Silicon's UNDOK™ app. The app offers comprehensive remote control functionality for FS based audio modules with an iOS or Android smart device.

To install and use the UNDOK™ app:

1. Download the UNDOK™ app from “App Store” or “Google play” and install it on your iOS or Android smart device.



2. Connect your smart device to the same Wi-Fi network as MEISTERSTÜCK.
3. Launch the UNDOK™ app on your smart device. The app will search for compatible audio systems. You may also tap on “Set up audio system” to start searching for audio systems.

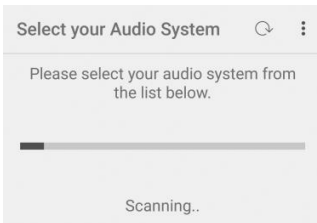

4. Select “Meisterstueck” from the list of available audio systems.

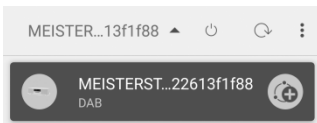

5. Control Meisterstueck through the UNDOK™ app.

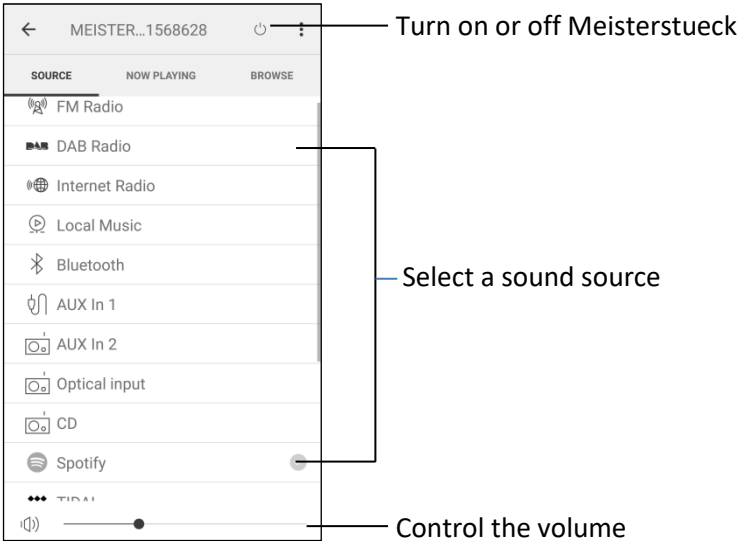

Your MEISTERSTÜCK can be used with other compatible products as part of a multi-room system. You can use the UNDOK™ app to manage the multi- room groups. To do so:

6. Tap on the edit group icon (🔗) in the list of available audio system.

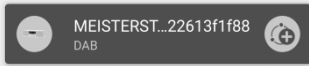

7. Add or remove MEISTERSTÜCK to or from multi-room groups, change a group name or delete a group as required.

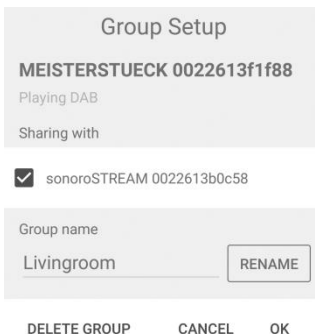

20 Troubleshooting

Malfunctions can occur with any electrical equipment. This is not necessarily due to MEISTERSTÜCK defect. As such, you should check the following table to see if you can eliminate the problem yourself.

Malfunction	Possible cause	Solution
No power	Power cable is not properly connected.	Connect the power cable properly.
No response from MEISTERSTÜCK	There is an error in MEISTERSTÜCK.	Disconnect and reconnect the power plug. Then turn MEISTERSTÜCK on again.
Remote control does not work, or only works sporadically	Distance to MEISTERSTÜCK is too large.	Reduce the distance between the remote control and MEISTERSTÜCK.
	Battery is empty.	Replace the battery.
No sound or poor sound	Sound is turned off.	Adjust the volume.
	MEISTERSTÜCK is not set to the correct playback mode.	Select another playback mode.
	Headset is plugged in.	Pull the headset out of the jack.
	FM/DAB or Internet reception is poor.	Extend/adjust the FM/DAB antenna or check the Wi-Fi connection.
	There is radio interference.	Keep MEISTERSTÜCK away from other electronic devices.
	Optical Input no sound	Select PCM as output source in the external device.

Malfunction	Possible cause	Solution
Insufficient Wi-Fi signal strength	The router is too far or blocked.	Place MEISTERSTÜCK closer to the router or adjust the position of the Wi-Fi antenna.
Cannot connect to your Wi-Fi network	Router is not switched on or working properly.	Switch on your router or check the router conditions.
	Setup method is incorrect.	Check if your router supports WPS and uses the correct setup method (PBC or PIN). Configure the Wi-Fi settings again.
Internet radio station does not work sometimes.	Some stations only support a limited number of listeners.	Try again later.
	Station is not broadcasting.	Try again later.
Some Internet radio stations disappear from the station list.	The station is removed from the list when it stops broadcasting.	Check again later. If the station broadcasts again, it will be brought back to the list.
CD playback does not start.	CD format is not supported.	Insert correct CD format in the CD slot.
	CD is dirty.	Clean the CD.
	CD is damaged.	Insert a different CD in the CD slot.
USB device does not work.	USB playback is not support.	Check the files and file system on the USB device.
	USB device is not charging.	Check the USB cable.

21 Cleaning

NOTICE!

Material damage due to improper cleaning!

Improper cleaning can result in damage to MEISTERSTÜCK or cause certain functions to stop working.

- Never use abrasive or solvent-based cleaning agents, as these may damage the surface of MEISTERSTÜCK.
- Never use hot or compressed air to dry MEISTERSTÜCK.
- The edges and corners of MEISTERSTÜCK are vulnerable to pressure. Protect these areas to prevent them from being subjected to excessive pressure.

Cleaning off fingerprints and light soiling

- Clean MEISTERSTÜCK only from the outside with a soft, dry cloth.

Cleaning off heavy soiling

- Clean MEISTERSTÜCK only from the outside with a slightly damp cloth and then dry MEISTERSTÜCK with a soft, dry cloth.

22 Warranty

When submitting warranty claims, the following applies without restricting your legal rights:

- Warranty claims can only be asserted within a period of max. 2 years (1 year in North America and Australia), calculated from the date of purchase.
- sonoro audio GmbH shall, at its own discretion, repair or replace MEISTERSTÜCK free of charge any defects caused by material or manufacturing defects within the warranty period.
- In case of a complaint, please contact our customer service department. You can find contact details under “Contact data” or at www.sonoro.de.
- No new warranty period begins following repair or replacement of MEISTERSTÜCK. The warranty period of 2 years (1 year in North America and Australia) from date of purchase remains applicable.
- Excluded from the warranty are batteries, damage caused by improper use, normal wear and tear, as well as defects which only minimally affect the value or usability of MEISTERSTÜCK. The warranty also expires in case of any modifications not made by our authorised service centre.

sonoro audio GmbH

Nordkanalallee 94

41464 Neuss

Allemagne

Téléphone: +49 2131 8834-141

Fax: +49 2131 7517-599

E-mail: support@sonoro.de

Internet: www.sonoro.de

DISTRIBUTED BY

TURA

www.turascandinavia.com